



**DOWNLOAD ENHANCED  
INSTALL MANUALS AT  
*dieselpowerperformance.com***



## **Universal Inline Exhaust Brake Remote Mount BD Exhaust Brake**

<b>1028030</b>	<b>W/O Air Compressor</b>	<b>3.0" Exhaust</b>
<b>1028035</b>	<b>W/O Air Compressor</b>	<b>3.5" Exhaust</b>
<b>1028040</b>	<b>W/O Air Compressor</b>	<b>4.0" Exhaust</b>
<b>1028050</b>	<b>W/O Air Compressor</b>	<b>5.0" Exhaust</b>
<b>1028130</b>	<b>W/ Air Compressor</b>	<b>3.0" Exhaust</b>
<b>1028135</b>	<b>W/ Air Compressor</b>	<b>3.5" Exhaust</b>
<b>1028140</b>	<b>W/ Air Compressor</b>	<b>4.0" Exhaust</b>
<b>1028150</b>	<b>W/ Air Compressor</b>	<b>5.0" Exhaust</b>

Serial # \_\_\_\_\_

Date Purchased \_\_\_\_\_

Purchased from \_\_\_\_\_

Installed by \_\_\_\_\_

**Please read the entire installation manual prior to starting installation. This is a universal kit and may require additional parts not included in this kit.**

**OWNER'S MANUAL - LEAVE IN GLOVE BOX**

**The brake pressure at idle must be checked and adjusted at time of install, at least two weeks after install, and at regular twice a year intervals.**

# Table of Contents

<b>Introduction .....</b>	<b>3</b>
<b>Vehicle Requirements .....</b>	<b>3</b>
<b>Kit Contents .....</b>	<b>4</b>
<b>Tools Required .....</b>	<b>6</b>
<b>Optional Parts .....</b>	<b>7</b>
<b>Installation .....</b>	<b>8</b>
Brake Valve Installation .....	8
Regulator/Air Valve Mounting .....	9
Air Compressor Installation – Kits with Compressor ONLY .	10
Air Supply Source – Kits without Compressor ONLY .....	12
Exhaust Brake Air Hose Installation .....	13
Air Regulator/Solenoid Assy. Electrical Connections .....	14
Toggle Switch Installation .....	15
DFIV Module Installation .....	16
Micro Switch Installation (Optional) .....	18
DFIV Adjustment .....	19
<b>Brake Wiring &amp; Plumbing Diagram – With Compressor .....</b>	<b>20</b>
<b>Brake Wiring &amp; Plumbing Diagram – Without Compressor ...</b>	<b>21</b>
<b>Wiring Diagram – DFIV Module .....</b>	<b>22</b>
<b>Wiring Diagram – Optional Micro Switch .....</b>	<b>22</b>
<b>Exhaust Back Pressure Testing for Air Actuated Brakes .....</b>	<b>23</b>
Idle Pressure Test.....	23
Off-Idle Pressure Test & Adjustment .....	24
<b>Maintenance.....</b>	<b>25</b>
<b>Troubleshooting .....</b>	<b>26</b>

## ***Introduction***

Exhaust brakes help slow down your vehicle by increasing the retarding horsepower available from your engine. Exhaust brakes are highly recommended for use when hauling heavy loads and for long hill descents.

This exhaust brake kit is for universal applications including pickup trucks, medium duty trucks and motorhomes.

This is a universal kit, it is provided with the parts necessary for exhaust brake operation; however the vehicle specific components including bracket mounting, tube routing/length and wiring will require field modification to suit the application. Do not proceed with installation if you are uncomfortable with this aspect of installation.

Measure the exhaust pipe outside diameter in the area the brake valve will be installed, order the kit corresponding to this size. If your vehicle is already equipped with onboard air capable of supplying at least 100psi, order the kit without air compressor. Otherwise you will need the kit that includes an air pump.

This manual is divided into different areas to assist you with the installation and operation of your braking unit. We strongly suggest that you write down the kit and serial numbers of your unit in the spaces provided and retain this manual for future reference.

## ***Vehicle Requirements***

This exhaust brake is only intended for vehicles **without** exhaust after treatment (SCR), particulate filter systems (DPF) or exhaust gas recirculation (EGR).

Using this kit with SCR or DPF systems will exceed the designed temperatures of the brake valve and cause seizing and premature failure.

Using this kit with an EGR system will reduce brake effectiveness by bleeding exhaust brake pressure back to the intake manifold.



If utilizing the vehicles on-board air compressor/air tank ensure the air supply is capable of delivering 100psi of air for the brake system to actuate.

# Kit Contents

Confirm you have all the parts listed in this kit before proceeding





All kits come with the following components:

<p><b>1127038-A</b></p>	<p><b>1100404</b></p>	<p><b>1220112</b></p>
		
<p>Brake Valve <b>Qty: 1</b></p>	<p>Marmon Clamps <b>Qty: 2</b></p>	<p>Air Tubing Kit <b>Qty: 1</b></p>

<p><b>1321039</b></p>	<p><b>1607314</b></p>	<p><b>1300131</b></p>
		
<p>DFIV Controller Kit <b>Qty: 1</b></p>	<p>Extra Wire (for pusher motorhomes) <b>Qty: 50 feet</b></p>	<p>6" Wire Ties <b>Qty: 12</b></p>

<p><b>1459140</b></p>	<p><b>1300529</b></p>	<p><b>1320102</b></p>
		
<p>Tube Clamp 5/8" <b>Qty: 4</b></p>	<p>Self-Tap #8x1/2" <b>Qty: 6</b></p>	<p>Flat Washer #8 <b>Qty: 6</b></p>



These parts included only in kits with air pumps (10281XX)

1030126	1220146	1500359	1500357
			
Air Pump Assembly	Regulator/Solenoid Assembly	Self-Thread 3/8\" Bolt	Washer 3/8\"
<b>Qty: 1</b>	<b>Qty: 1</b>	<b>Qty: 4</b>	<b>Qty: 4</b>

These parts included only in kits without air pumps (10280XX)

1220410	1220147	1220416
		
1/4\" Air Line	Regulator/Solenoid Assembly	1/4\" Line to 1/8\" NPT Fitting
<b>Qty: 10ft</b>	<b>Qty: 1</b>	<b>Qty: 1</b>



1028X30 3\" Kit

1100300	1100730
	
3\" Adapter Pipe	3\" Exhaust Clamp
<b>Qty: 2</b>	<b>Qty: 1</b>



1028X35 3.5\" Kit

1100350	1100735
	
3.5\" Adapter Pipe	3.5\" Exhaust Clamp
<b>Qty: 2</b>	<b>Qty: 1</b>

## 1028X40 4" Kit

1100400	1100740
	
4" Adapter Pipe	4" Exhaust Clamp
Qty: 2	Qty: 1





## 1028X50 5" Kit

1100500	90368B
	
5" Adapter Pipe	5" Exhaust Clamp
Qty: 2	Qty: 1

## ***Tools Required***

- Measuring tape or ruler
- Reciprocating saw or hacksaw
- Wire Crimping Pliers
- Drill
- Socket Set
- Heat gun or lighter
- Welder

## Optional Parts

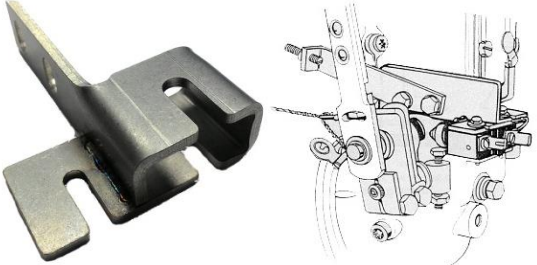
Description	Part #
<p>Brake Pressure Testing Gauge</p> <p>Recommended for setting exhaust brake backpressure.</p>	 <p>1030050</p>
<p>Throttle Switch (preferred)</p> <p>Alternative to the DFIV controller Requires custom bracketry to install Fits in the two brackets below</p>	 <p>1300420</p>
<p>Throttle Switch with Arm</p> <p>Comes with universal bracket</p>	 <p>1300440</p>
<p>Bracket for VE Pumps</p> <p>Fits 1300420 throttle switch Bolts to timing cover on front of 5.9L engine with VE rotary injection pump</p>	 <p>1300535</p>
<p>Bracket for P7100 Pumps</p> <p>Fits 1300420 throttle switch Bolts to P7100 inline injection pumps.</p>	 <p>1300523</p>

# Installation

To prevent damage to electronic components, it is recommended that all batteries be disconnected by removing the negative terminals while working on the vehicle.

**Please read this manual thoroughly before installing this exhaust brake.**

## Brake Valve Installation



Raise and support the vehicle with a vehicle hoist or with appropriate jack stands.

Ensure vehicle is safely supported before proceeding to reduce possibility of damage or injury.

Beneath the vehicle, locate the exhaust pipe where it leaves the engine, and locate a straight section of pipe downstream of this to mount the valve.

Try to install the valve ahead of flanges or slip joints that may leak exhaust pressure. The brake must be mounted ahead of mufflers or catalytic converters.

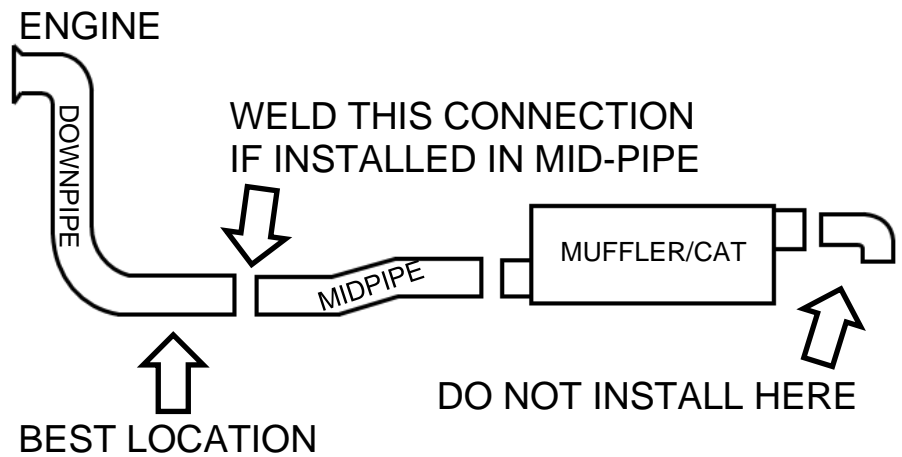

Loosely assemble the exhaust brake casting to the supplied front pipe and rear adapter pipe and mock up the area it will be installed in. Ensure the brake valve actuator will not interfere with vehicle components.

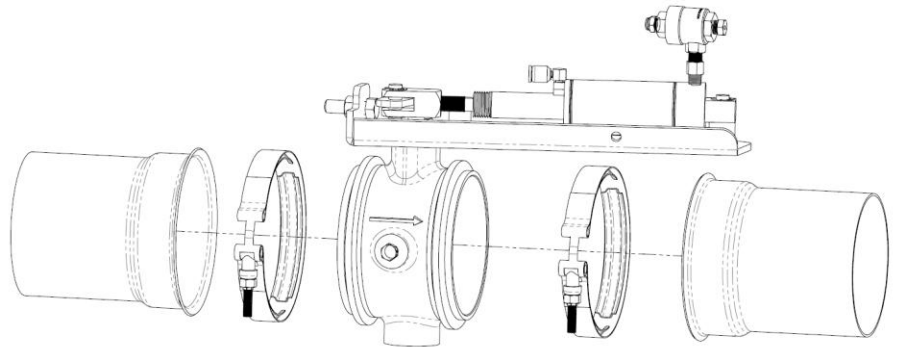

Mark the vehicles exhaust pipe in the location to be cut so that it will overlap sufficiently with the supplied adapters and cut out this section.

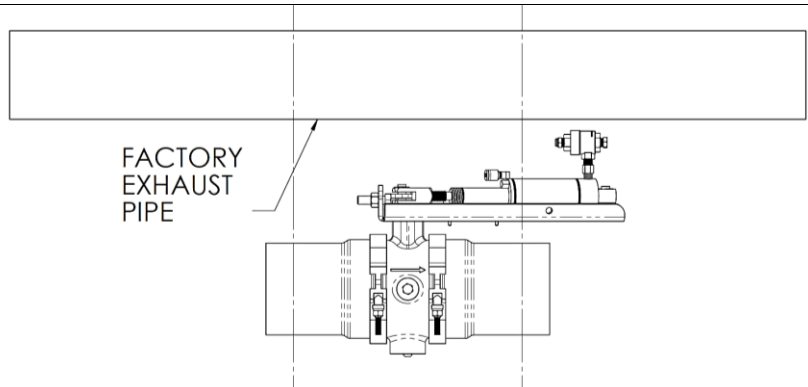



Disassemble the exhaust pipe adapters from the brake valve and slide one of them on the front exhaust pipe. Fully weld this to the pipe to create a complete seal.

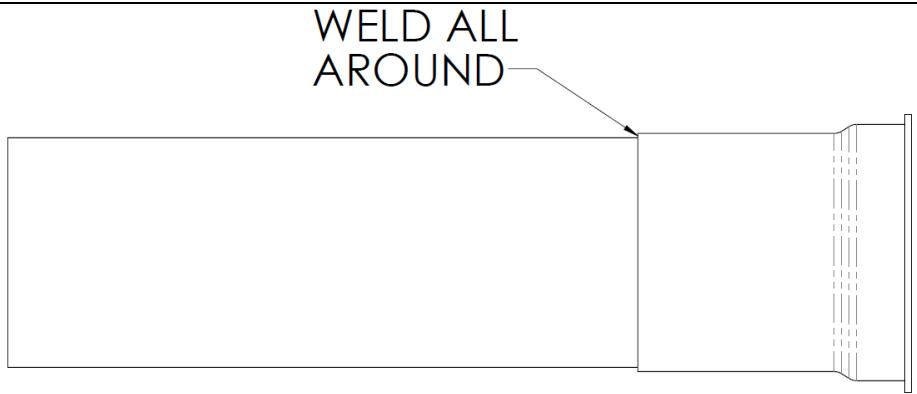

**IMPORTANT** If using a two piece downpipe or installing the valve downstream of exhaust pipe joints, it is strongly recommended that the all joints be welded fully to prevent exhaust leaks when the brake is on. Leaking exhaust will reduce the brake effectiveness, may emit soot in the engine bay and exhaust gas could be drawn into the vehicle cabin.

Slide the exhaust clamp over the existing rear exhaust pipe and slide the rear brake adapter onto the rear pipe.

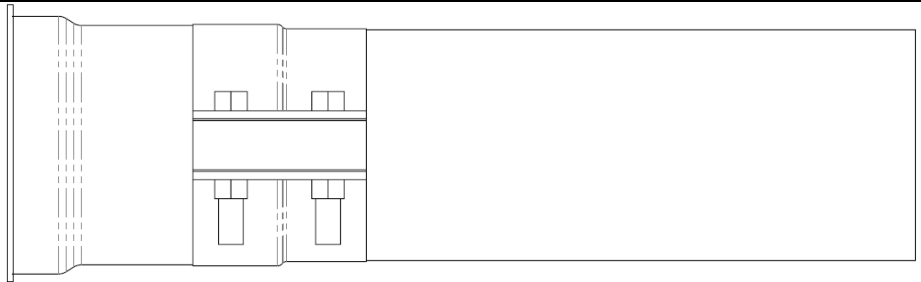

Clamp the exhaust brake assembly between the two flanges with the Marmon clamps. Align brake valve to pipes and so that it is clear of vehicle obstructions. Tighten clamps.

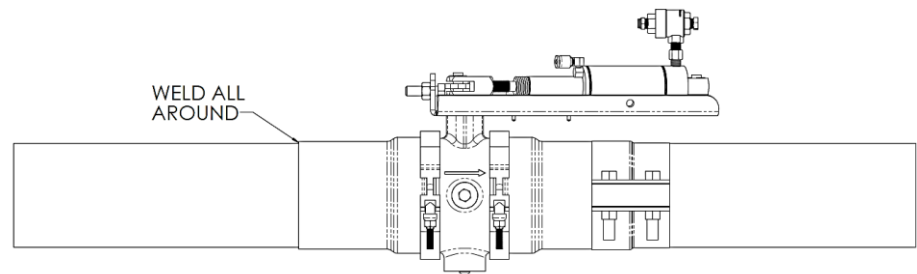

Now that the brake valve is aligned correctly, tighten the rear exhaust clamp.

## Regulator/Air Valve Mounting

The air pressure regulator/solenoid assembly is to be mounted in a dry location, generally in the engine compartment. Ensure it is far away from exhaust components. The firewall or fender areas are generally good locations.

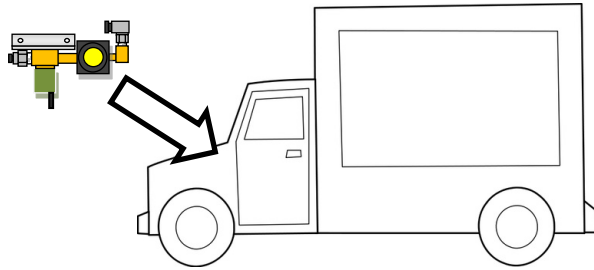

Mount the air pressure regulator/solenoid assembly using two self-tapping screws provided (1300529) or by other secure means.

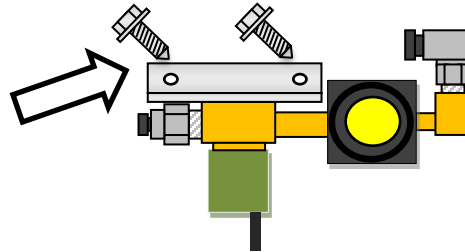

Leave the wiring connections for now.

## Air Compressor Installation – Kits with Compressor ONLY

Locate a flat section of frame rail to install the air compressor assembly. The bracket has four holes in it that may be used for installing mounting fasteners. The compressor may also be mounted on the body if space permits.

**NOTE** If mounted to the body, vibration transfer will be greater and the pump will be louder in the cab.

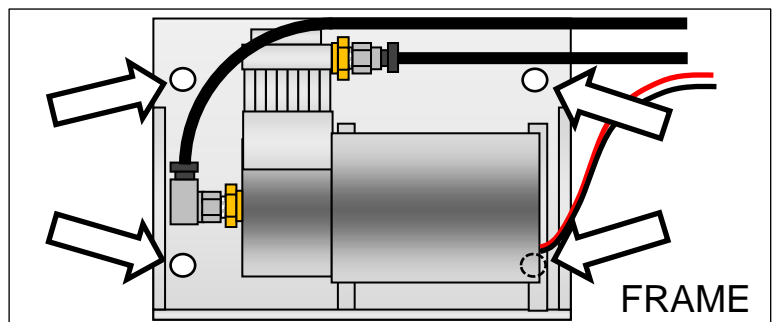

Four self-threading screws and four washers (1500369 and 1500367) have been provided which may be used for direct frame mounting. If using these fasteners, mock up the pump assembly to the frame and scribe the four holes thru to the frame. These will be the drill locations. Use a center punch to make a dimple, and then drill a 1/8" pilot hole. Now drill the final 21/64" holes. Install the bolts with a 9/16" socket and air ratchet.

**NOTE** It may be easier to mock up if the pump is temporarily removed from the bracket.

Route the air line/wire assembly from the air pump to the air regulator/solenoid assembly. Keep these lines away from the exhaust or sources of heat. Secure with zip ties to existing wiring harnesses or to the frame.

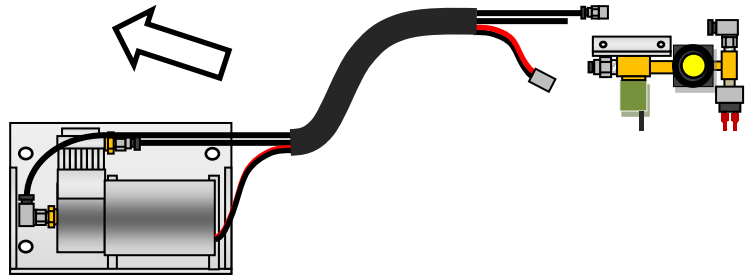

Thread in the supplied “pancake” air filter to the fitting on the air suction line. Zip tie this filter in the engine compartment in a clean dry location.

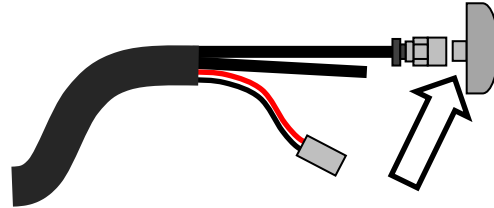

Connect the pressure feed to the air regulator inlet fitting on the air regulator/solenoid assembly. Trim to the correct length if necessary.

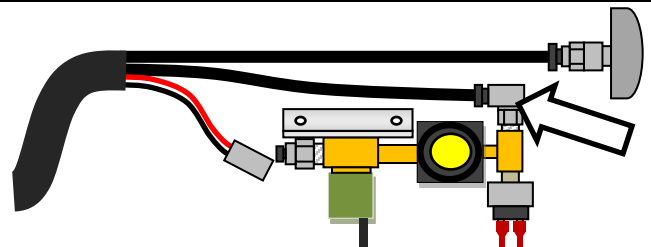

Plug the 2 pin gray plug from the pump into the wire harness attached to the regulator/solenoid assembly.

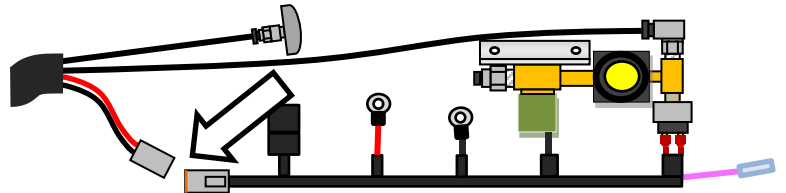

Mount the relay socket or zip-tie it in place near the air regulator/solenoid assembly.

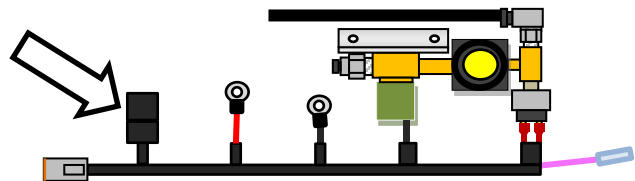

## Air Supply Source – Kits without Compressor ONLY

Kits without an air compressor must tie into the vehicles existing onboard air. Bleed down the air pressure in the air tank by opening the drain valve or other means before proceeding.

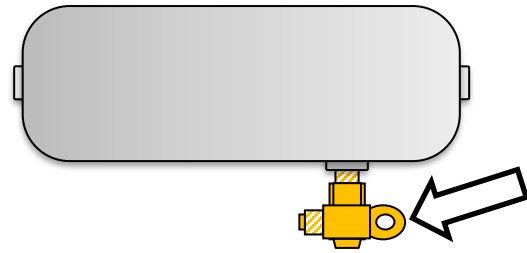

If the air tank has a spare 1/8"NPT outlet fitting install here. Otherwise the installer will have to supply fittings to allow for a 1/8"NPT fitting to be installed.

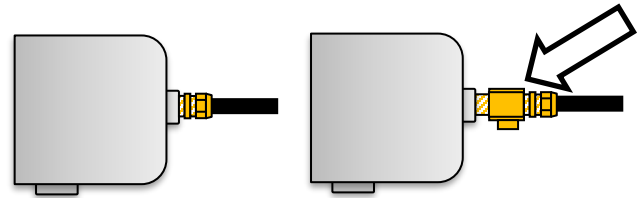

**Note** Do not connect the air line to the bottom of the air tank or water may enter the system and cause damage.

Install the supplied 1/8"NPT to 1/4" tube adapter (1220145) into the air tank system

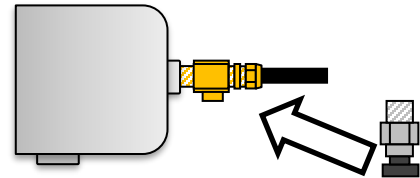

Insert one end of the plastic tube (1220410) into the fitting and route the tube to the regulator/air valve. Secure the line and keep it away from sources of heat or abrasion.

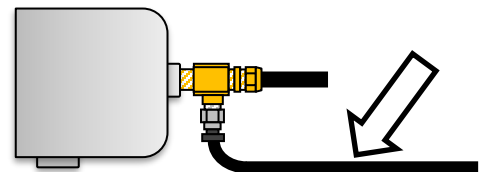

Install this air line into the inlet of the air regulator/solenoid assembly.

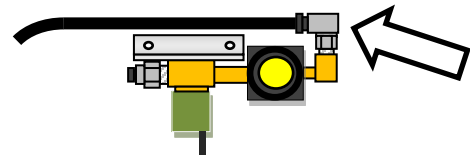

## Exhaust Brake Air Hose Installation

This kit is supplied with a premade air tubing assembly. The 1/8" air tube is the pressurized air feed to the brake pneumatic cylinder and the 1/4" air tube is the vent line for the cylinder.



Insert the 1/8" air tube into the quick connect fitting on the quick release valve on the brake air cylinder.

Insert the 1/4" tube into the vent-side quick connect fitting.

Support the air tubing assembly to ensure there is no stress on the air lines. This can be zip tied to the frame or a nearby harness.

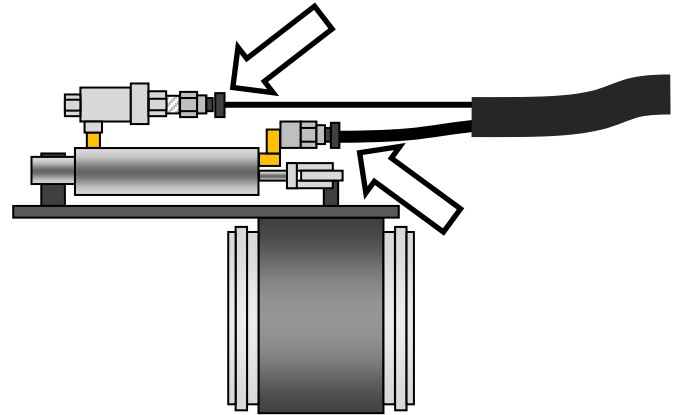

Route the air tubing assembly toward the air regulator/solenoid, supporting it with zip ties.

This can be zip tied to the frame rail or existing wiring harnesses.

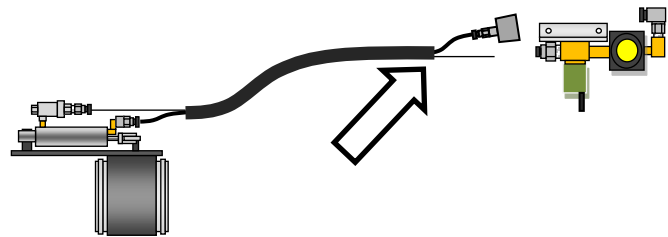

Connect the 1/8" line (brake cylinder) to the air regulator/solenoid output fitting. Position the air filter in a clean dry location nearby. Trim lines to length if needed.

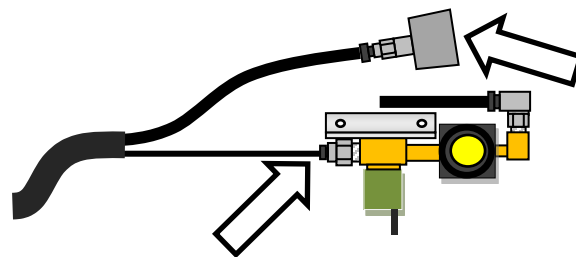

## Air Regulator/Solenoid Assy. Electrical Connections

### WITH COMPRESSOR ONLY

Locate the black wire with ring terminal in the air regulator/solenoid assembly wiring harness. Connect this to body ground by installing under a body or frame bolt.

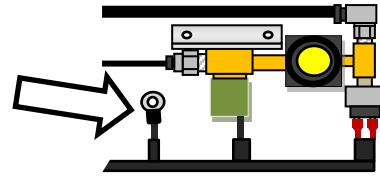

### WITHOUT COMPRESSOR ONLY

Locate the brown wire with a ring terminal from the air solenoid wire. Connect this to body ground by installing under a body or frame bolt.

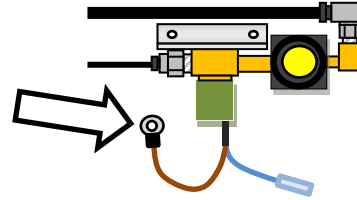

### WITH COMPRESSOR ONLY

Locate the red wire with ring terminal in the air regulator/solenoid assembly wiring harness. Connect this to the battery positive terminal or to a powered stud in the vehicles fuse box.

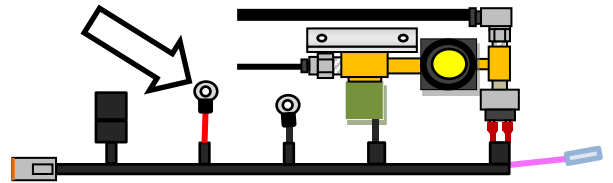

Leave the small PINK or BLUE wire for now, this will be connected to the output of the DFIV or micro switch in the following sections.

## Toggle Switch Installation

Locate the toggle switch supplied with the DFIV kit. This is the toggle switch that will turn the exhaust brake on and off. Locate a spot to mount it in the dash. Ensure there is sufficient room behind the dash for the switch and wires before drilling.

Install the decal and secure the switch with the supplied nut.

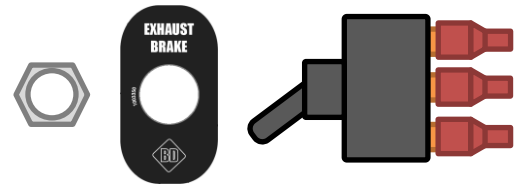

Remove the fuse from the fuse holder for now, only install once installation is complete.

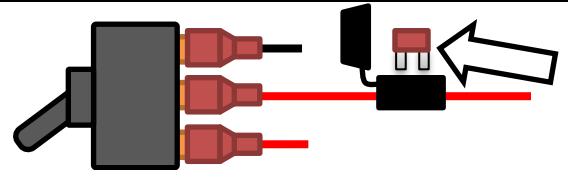

Connect the BLACK wire from the switch to a body ground.

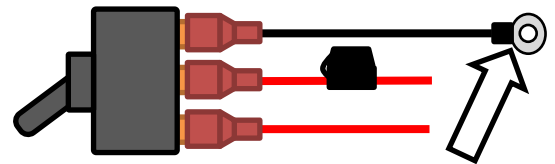

Connect the RED wire from the MIDDLE of the switch to a switched ignition circuit (this is the wire with the fuse holder). If wiring diagrams are available reference those. Otherwise use a test light to locate a switched 12v source. This should only be powered with the ignition switch in the ON position. Use a supplied posi-tap connector to attach this wire.

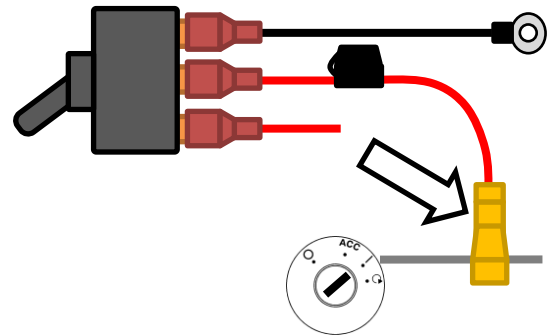

**CAUTION** Only probe ignition switch or fuse box wires. Ensure to avoid possible contact with airbag or sensor wiring.

The remaining red wire from the switch is the power out to the DFIV or micro switch, this will be connected in the next section.

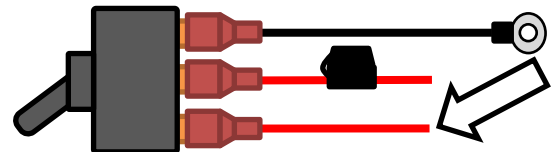

## DFIV Module Installation

The DFIV module will control the exhaust brake activation based on throttle pedal position, it requires the vehicle have an accelerator pedal position sensor (APPS) or a throttle position sensor (TPS). If no sensor signal is available, the installer may need to use a micro switch instead. See next section.

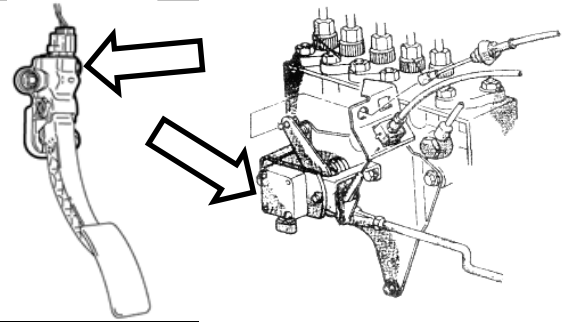

Locate a throttle position sensor signal that RISES with throttle position. If wiring diagrams are available for the vehicle then consult those. If not, use a digital multi-meter set to volts DC and probe the various wires of the TPS or APPS to locate a signal that rises with pedal position. This is the wire we will use for the APPS signal of the DFIV module.

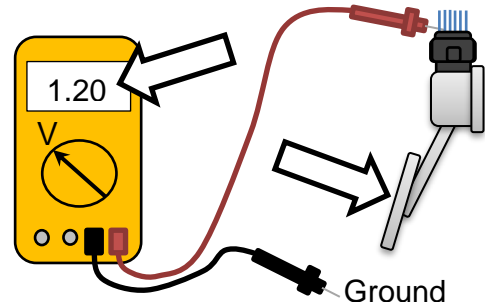

Mount the DFIV module in the cabin of the vehicle, generally under the dash is preferred. Do not install in the engine bay, it is not weather resistant. You may mount it with the supplied zip ties. Ensure the adjustment dial on the side will remain accessible.

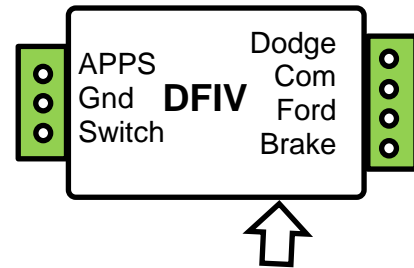

Connect the remaining RED wire from the toggle switch into the DFIV module in the terminal labelled SWITCH. Strip the end of the wire and tighten the small screw to hold the wire in place, tug on it to ensure it is securely installed.

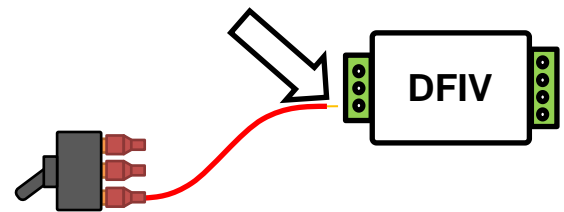

Locate the BLACK wire in the DFIV kit, this should already have a ring terminal installed on the end. Install the ring terminal under a bolt nearby to provide a ground and route the wire to the module, cut to length, strip the end and install in the GND terminal of the DFIV module.

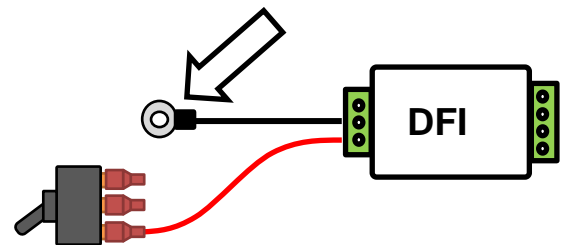

Locate the YELLOW wire in the DFIV kit, this will be used to connect the APPS/TPS signal wire to the DFIV module. RED posi-lock connectors are supplied to tap into this wire, alternatively you may solder this connection. Install this wire into the APPS terminal of the DFIV module.

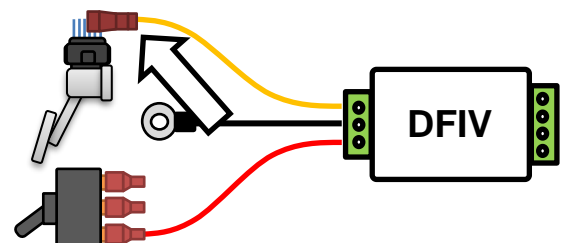



Locate the PINK wire supplied with the DFIV kit, install the end of this wire in the terminal labelled BRAKE, this is the 12v output to the exhaust brake air solenoid. Route this wire to the location that the air regulator/solenoid is installed in the engine bay.

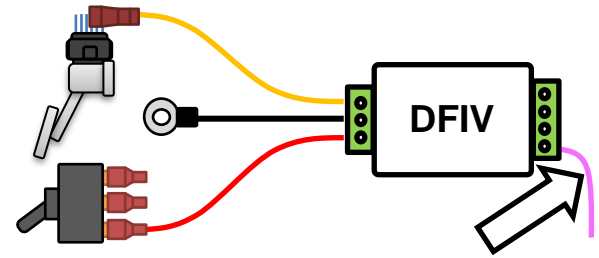

**NOTE** Pusher motorhomes will need additional wire length to reach from the APPS sensor under the dash to the engine compartment in the rear, for these installations use the long length of PINK wire supplied and discard the short length.

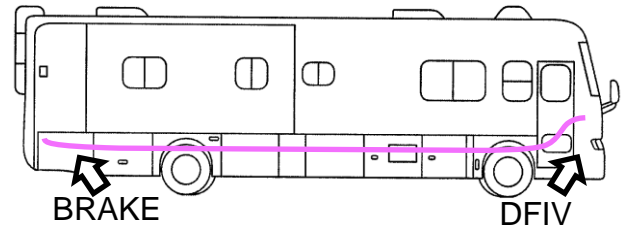

#### WITH AIR COMPRESSOR ONLY

Connect the PINK wire to the PINK wire from the air solenoid/regulator kits PINK wire. Use the pre-installed heat shrinkable butt connector. Crimp the connection then use a heat gun to seal the connection.

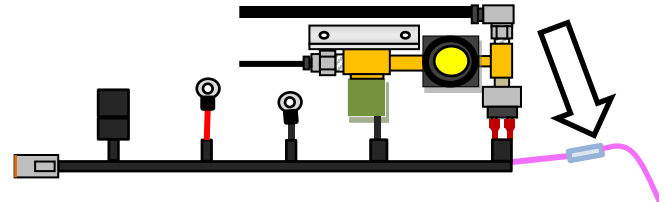

#### WITHOUT AIR COMPRESSOR ONLY

Connect the PINK wire to the BLUE wire from the air solenoid. Use the pre-installed heat shrinkable butt connector. Crimp the connection then use a heat gun to seal the connection.

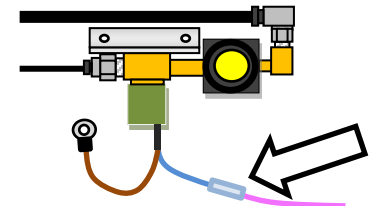

Refer to the wiring diagrams at the end of the installation manual.

Cover wires with the supplied loom from the DFIV kit.

**NOTE** The COMMON, FORD, DODGE terminals of the DFIV are not used for this installation.

## Micro Switch Installation (Optional)

For vehicles with fully mechanical injection systems that do not have a throttle position sensor it may be necessary to install a micro switch to control the brake. This part is not included but may be ordered separately.

No brackets are supplied for this, the installer must fabricate a bracket to position the switch so that it is pressed when the throttle is at idle and so that the micro switch button is released when the throttle is pressed. This can be installed either directly on the throttle pedal (preferred) or on the engine at the injection pump throttle cable mechanism.

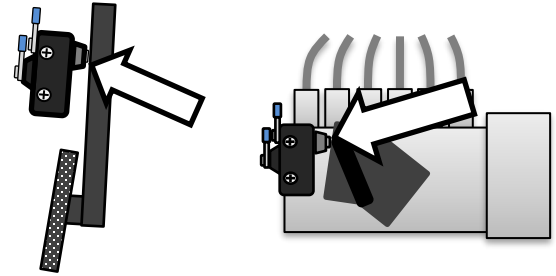

Run the remaining red wire from the toggle switch to the micro switch and crimp it to one of the switch terminals.

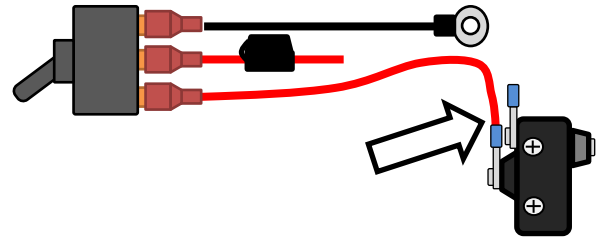

Crimp the PINK wire out of the DFIV kit into the other micro switch terminal. Route this wire to the vehicles engine bay to the location where the air regulator/solenoid assembly is located.

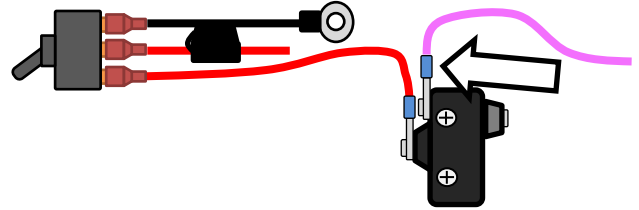

**NOTE** Pusher motorhomes will need additional wire length to reach from the APPS sensor under the dash to the engine compartment in the rear, for these installations use the long length of PINK wire supplied and discard the short length.

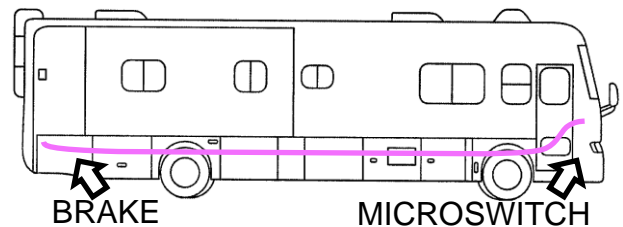

### WITH AIR COMPRESSOR ONLY

Connect the PINK wire to the PINK wire from the air solenoid/regulator kits PINK wire. Use the pre-installed heat shrinkable butt connector. Crimp the connection then use a heat gun to seal the connection.

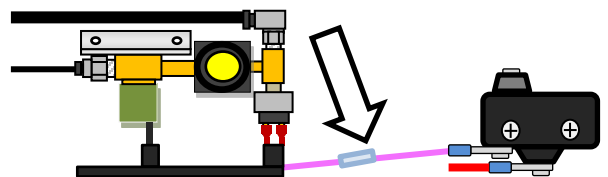

### WITHOUT AIR COMPRESSOR ONLY

Connect the PINK wire to the BLUE wire from the air solenoid. Use the pre-installed heat shrinkable butt connector. Crimp the connection then use a heat gun to seal the connection.

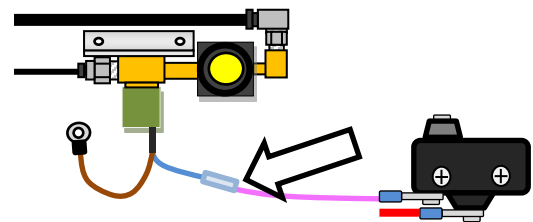

Refer to the wiring diagrams at the end of the manual for additional information. Cover exposed wiring with the loom provided in the DFIV kit.

## DFIV Adjustment

Reinstall the fuse removed from the toggle switch earlier. Ensure the installation of the exhaust brake is complete and that the vehicle is ready to be started and tested. Reconnect vehicle batteries if disconnected.

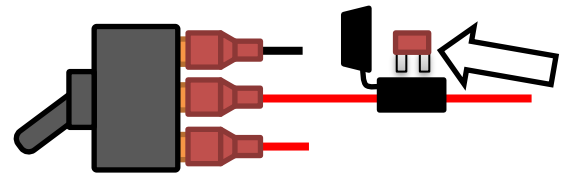

Turn the ignition to ON but do not start the engine. Turn on the exhaust brake toggle switch. The switch should illuminate.

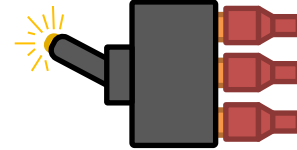

Attach a test light to the BRAKE terminal of the DFIV module. You will need a small flat bladed screw driver to adjust the DFIV modules adjustment screw. With the throttle at idle; slowly turn the adjustment clockwise and counterclockwise until the test light JUST comes on.



**CAUTION** The adjustment screw is delicate

Now as the throttle pedal is applied the test light should go out. Adjust the screw further if needed to ensure it turns off as soon as the throttle pedal is pressed but still turns on when the pedal is released. The DFIV adjustment is complete. You will also hear the brake valve shutting and opening during this test.

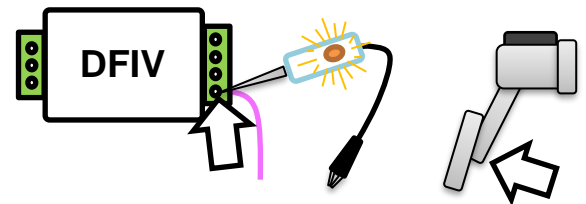

You may now road test the vehicle and make backpressure adjustments as necessary.

# Brake Wiring & Plumbing Diagram – With Compressor

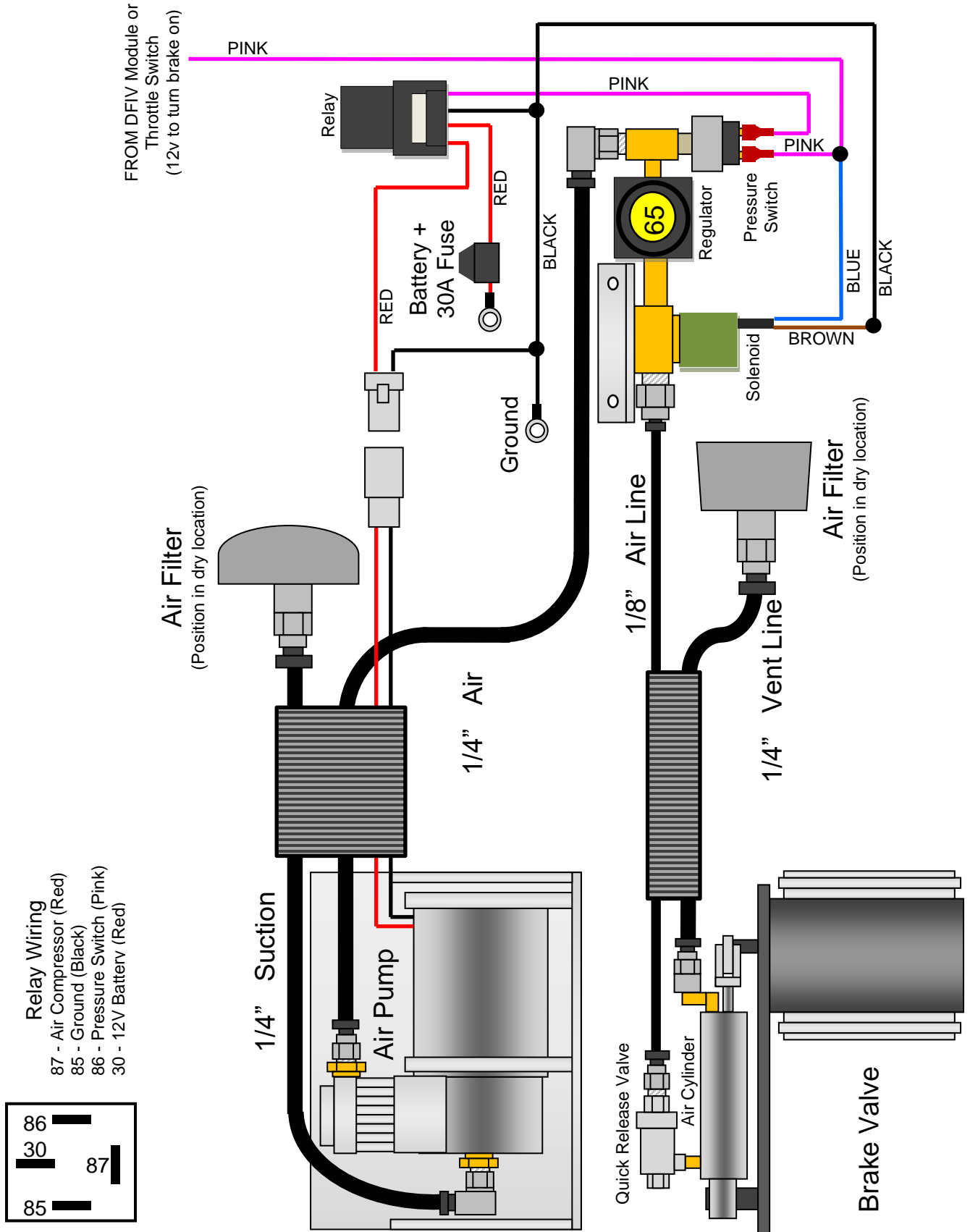

# Brake Wiring & Plumbing Diagram – Without Compressor

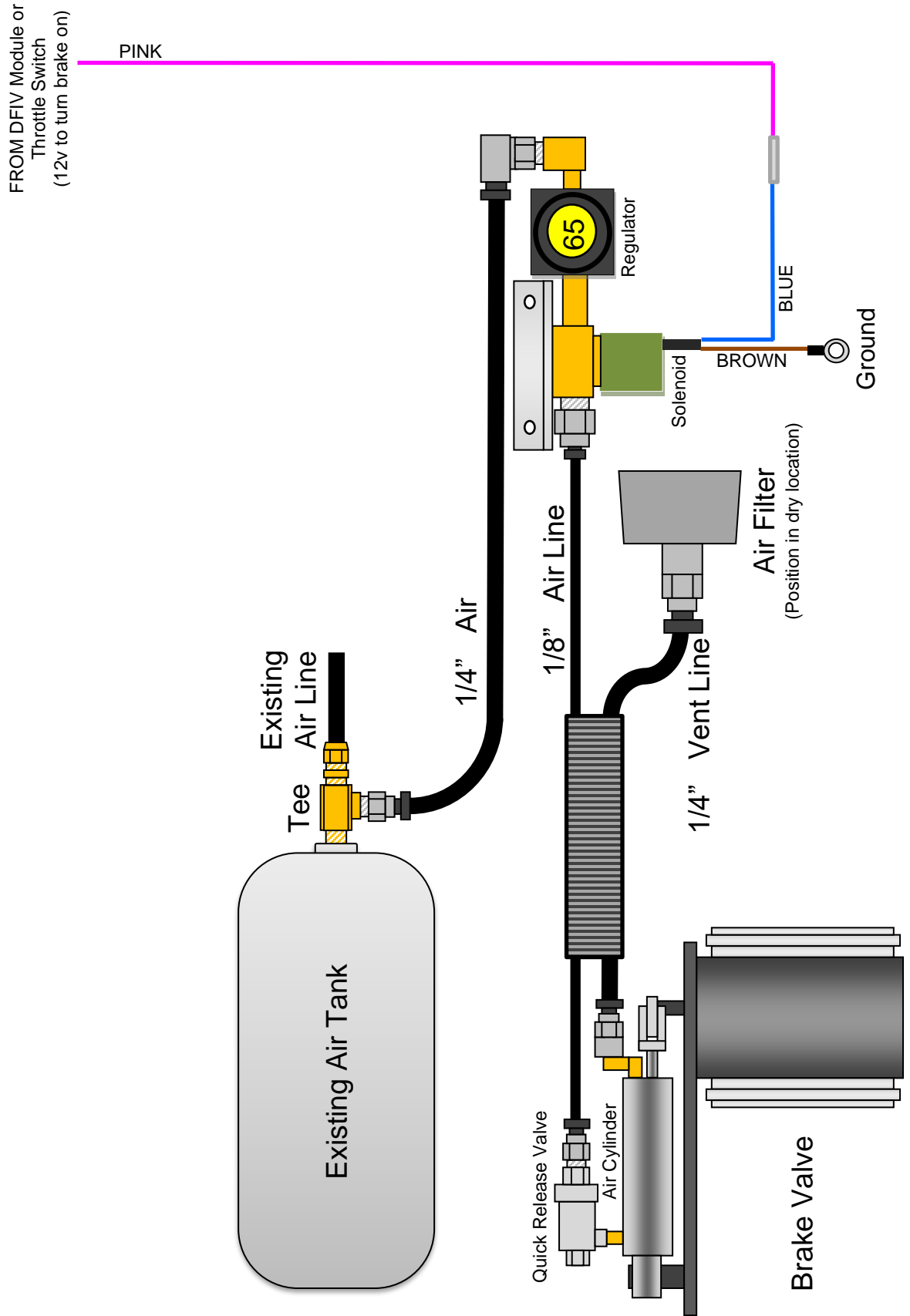

# Wiring Diagram – DFIV Module

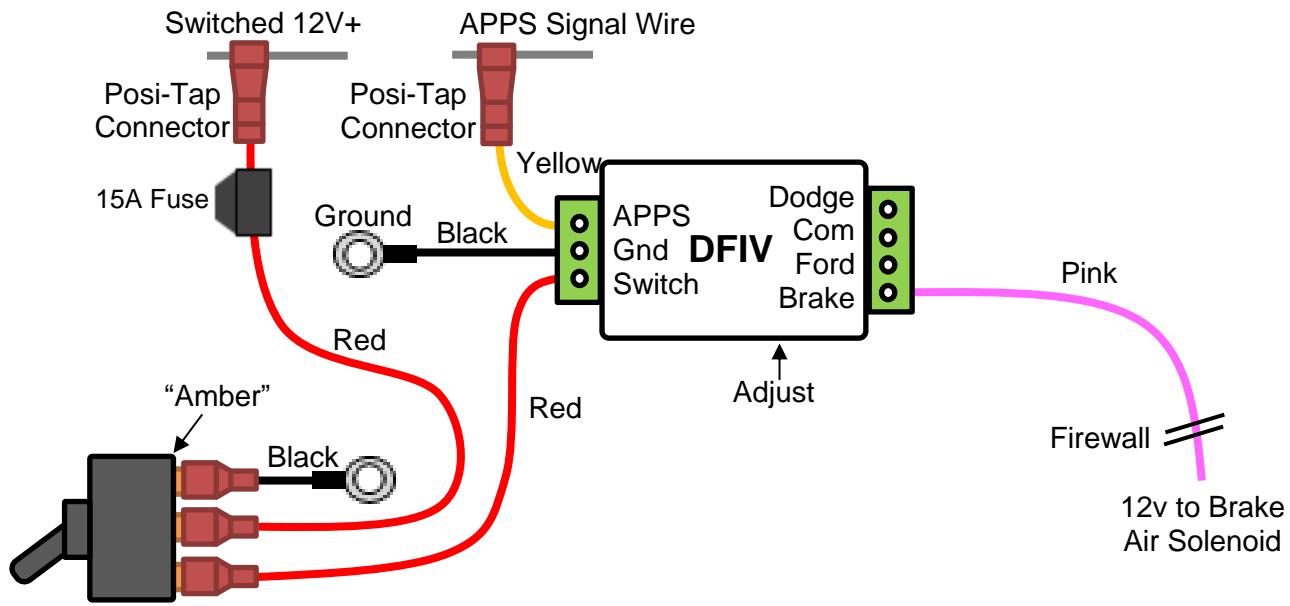

# Wiring Diagram – Optional Micro Switch

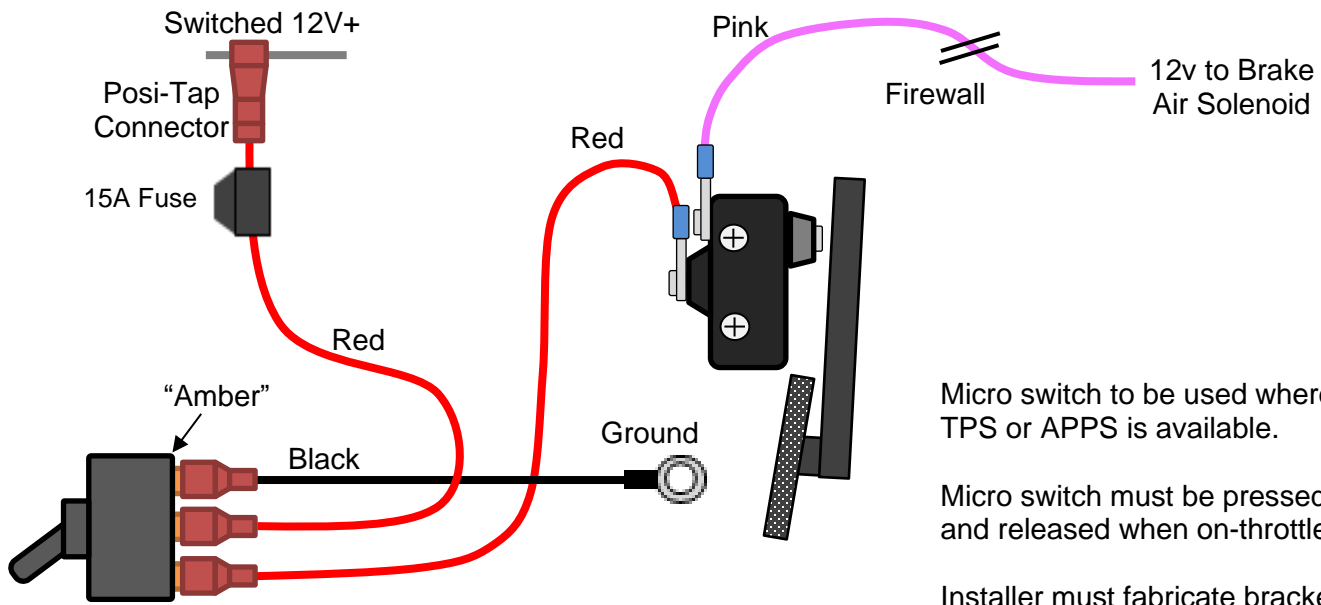

## ***Exhaust Back Pressure Testing for Air Actuated Brakes***

To test exhaust brake system pressure, a minimum 0-100psi pressure gauge is required.

We recommend purchase of a BD brake pressure gauge kit #1030050.



**You do not need to measure the air pressure in the system, just the exhaust backpressure, which is located on the cast valve.**



### **Idle Pressure Test**

With the BD brake engaged and the engine at idle check the exhaust backpressure using a pressure gauge (such as BD PN 1030050) at the test port on the brake valve.

If the back pressure is below 13 psi at idle you have a number of likely causes. The most common being an exhaust leak either at the clamp joint or at the welds (only on some models). Apply the exhaust brake and have someone assist you looking for soot trails or the visible leak. Another culprit would be an exhaust manifold leak, turbocharger gasket leak, turbocharger problem or an EGR issue.

If the back pressure is greater than 25psi, you will need to make an adjustment on the stop bolt. Loosen the jam nut, and lengthen the stop bolt towards the actuator, this will shorten the stroke distance. Only turn 1/4 rotation at a time and re-secure the jam nut. Retest idle pressure.

**NOTE: The brake stop-bolt and regulator have been preset at the factory and should not need to be adjusted.**

We generally do not recommend adjusting the stop bolt, please consult BD before doing this as it may void your warranty.

## Off-Idle Pressure Test & Adjustment

Your BD exhaust brake is a variable-orifice design so when the brake is active and the engine is at higher RPM the brake lever does not rest on the stop bolt. Off-idle backpressure is set by adjusting the air pressure regulator which will in turn increase or decrease off-idle exhaust backpressure. You will need to secure your pressure gauge somewhere that you can see it while you are driving. Using a long extension hose & bringing the gauge into the cab through an open window or clipping it under a windshield wiper works well.

Get the truck up to speed (a downhill grade or a load in the truck is helpful) and activate the exhaust brake. Note the maximum backpressure achieved. You should get peak backpressure at higher RPM (try 3000 RPM in Drive). If you cannot reach the desired backpressure (compare table below) you can begin troubleshooting, the first step is to look for exhaust leaks either from the clamps, exhaust manifolds or feed pipes. Also look for leaks at the clamps located at the back of the turbo and also at the down pipe. If all connections are sealed, you can then use the adjusting regulator to increase the backpressure. Note that small regulator adjustments can have a significant effect on off-idle backpressure.

Turning the regulator **clockwise** will increase pressure.  
Turning the regulator **counter clockwise** will decrease pressure.



**NOTE** Over the next two weeks, the backpressure at idle may rise due to initial carbon build up on the inside of the brake housing and on the butterfly. The stop bolt may need to be adjusted again to compensate.

**CAUTION** Do NOT exceed the maximum back pressure value in the exhaust system. Exceeding this pressure could force the exhaust valves open during the intake stroke which could cause engine damage.



CATERPILLAR 3116	55 psi
CATERPILLAR 3126	55 psi
CATERPILLAR 3208T	55 psi
CHEVY 6.5L	35 psi
CHEVY DURAMAX 6.6L	55 psi
CUMMINS 5.9L 12-VALVE W/ 40lb EXHAUST SPRINGS	40 psi
CUMMINS 5.9L 12-VALVE W/ 60lb EXHAUST SPRINGS	60 psi
CUMMINS 24-VALVE & COMMON RAIL	65 psi
CUMMINS 6.7L	65 psi
CUMMINS 8.3L	65 psi
CUMMINS L10	65 psi
FORD POWERSTROKE 6.0L	45 psi
FORD POWERSTROKE 6.4L	55 psi
FORD POWERSTROKE 6.7L	65 psi
FORD POWERSTROKE 7.3L	45 psi
FORD 7.8L	45 psi
NAVISTAR VT365	45 psi
NAVISTAR 444E & T444E	40 psi
NAVISTAR DT466 & DTA466	32 psi
NAVISTAR 466E	55 psi

\*If engine backpressure is not listed here, please check engine manufactures' specifications.

## ***Maintenance***

To extend life of the exhaust brake, do not operate the vehicle for extended periods of time without activating the brake. We suggest activating the exhaust brake at least a couple times a day while operating the vehicle to prevent any carbon or rust build up on inner parts of the brake valve assembly.

The hoses, wires, fittings and clamps should be inspected on a regular basis for any deterioration, damage or leaks.

**To increase the life of your exhaust brake, we recommend daily operation. By simply switching the brake on and off a couple times a day, it will prevent the butterfly valve from sticking due to carbon build-up.**

Following the diagrams in this manual, tracing hoses and wiring, checking continuity through electric components or checking for any lines that are disconnected, should solve any problems that may arise. If you have any problems or need replacement parts, call us at 1-800-887-5030, between 8:30am and 5:00pm Pacific Time.

## Troubleshooting

This guide assumes that your exhaust brake system is using a DFIV or micro-switch on the throttle. For other systems see the appropriate instruction manual.

Brake does not engage	No	Yes
<p>Is the PINK "brake output" wire powered when ignition on, brake switch on and throttle at idle?</p> <p>Check with test light at DFIV or micro switch.</p> <p>Air compressor fuse blown?</p>	<p>Check for power from toggle switch. Check ground at DFIV module.</p> <p>Check for APPS/TPS voltage present. DFIV adjustment may be necessary.</p> <p>Also check power &amp; ground at pump relay and make sure the air solenoid has a good ground.</p>	<p>Check that when air solenoid is powered it will allow air to flow from the #2 port out the #1 port.</p> <p>Air compressor fuse blowing indicates it is not shutting off by the pressure switch. Check pressure switch plumbing and function.</p>
The brake comes on but there's little or no holdback	No	Yes
<p>Check brake pressure at high RPM. (See back pressure chart)</p> <p>Are you getting maximum allowable backpressure at full RPM?</p>	<p>Check for exhaust leaks. A small leak can result in a significant decrease in back pressure. If no leaks are found try adjusting air regulator. Check for air leaks in brake system.</p>	<p>Try down shifting more aggressively. More RPM will give more holdback. Torque converter lockup will hold RPMs higher and substantially improve holdback.</p>
Everything seems to work, but the brake valve won't close	No	Yes
<p>Check that air is reaching brake air cylinder</p>	<p>Air solenoid or quick release valve are likely stuck, plugged or faulty. Clean or replace as required.</p>	<p>Cylinder or brake valve is seized. Remove the clevis pin on the end of the cylinder rod &amp; see if the valve lever can be moved freely.</p>
<p>The valve lever can be moved freely?</p>	<p>Try dismantling the brake &amp; cleaning the carbon out of it. If this does not work the brake valve will need to be replaced.</p>	<p>The cylinder is stuck and will need to be replaced.</p>
Problem	Solution	
<p>Air compressor runs in short bursts and brake is slow to apply.</p>	<p>There is a restriction in the air system, normally in the regulator or air solenoid. Remove the fittings from the regulator and air solenoid, you will likely find some corrosion or debris caught in them. Clean this out with a pick, small brush, compressed air and WD40 or similar lubricant.</p>	
<p>Air compressor runs continually.</p>	<p>Air leakage in the lines. Pump relay stuck on. Check operation of relay &amp; replace as required.</p>	
<p>Brake is slow to release.</p>	<p>Debris or corrosion is restricting the quick release valve or air solenoid. Clean as required.</p>	

Thank you and happy motoring.  
BD Engine Brake, Inc.